

- 10, 12 and 20 Input-Output base modules
- Expansion modules with 4 digital Inputs and 4 digital Outputs
- Expansion modules with analog Inputs-Outputs
- RS485 Modbus-RTU slave communication module
- USB or RS232 cable for connection to PC or operator panel
- Program backup memory connection
- On-board programming languages: Italian, English, Spanish, French, German, Portuguese, Chinese, Polish, Russian, Turkish.
- Software programming languages: Italian, English and Spanish
- HMI with graphic touchscreen display, 64k colors, format 4.3", 7" and 10.1".

**Micro PLCs**

Base modules .....	22 - 4
Expansion and communication modules.....	22 - 4
Accessories .....	22 - 5
Kit .....	22 - 5

<b>HMI</b> .....	<b>22 - 7</b>
------------------	---------------

<b>Dimensions</b> .....	<b>22 - 8</b>
-------------------------	---------------

<b>Wiring diagrams</b> .....	<b>22 - 9</b>
------------------------------	---------------

<b>Technical characteristics</b> .....	<b>22 - 10</b>
--	----------------



**SEC. - PAGE**



Page 22-4

### MICRO PLCs

- 10 Inputs/Outputs (LRD10...)
- 12 Inputs/Outputs (LRD12...)
- 20 Inputs/Outputs (LRD20...)
- 12VDC, 24VDC, 24VAC or 100...240VAC power supply
- Relay or transistor outputs.



Page 22-4

### EXPANSION AND COMMUNICATION MODULES

- 4 digital inputs / 4 digital outputs
- Analog inputs, 0...10V or 0/4...20mA
- Analog outputs, 0...10V or 0/4...20mA
- Relay or transistor outputs
- PT100 temperature sensor inputs
- Modbus-RTU protocol slave communication unit
- 24VDC, 24VAC or 100...240VAC power supply.

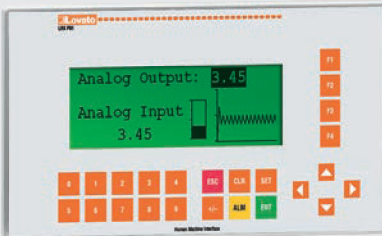

Page 22-5

### ACCESSORIES

- Program backup memory
- Programming and supervision software
- Power supply unit
- HMI operator panel with graphic LCD.



Page 22-5

### STARTER AND TRAINING KITS

- Complete kit to begin using micro PLCs, each equipped with LRD micro PLC, programming and supervision software and USB connecting cable
- Training kits complete with micro PLC and Inputs/Outputs simulation board.



Page 22-7

### HMI

- TFT graphic display with touchscreen, 64k colors
- Available in formats 4.3", 7" and 10.1"
- Programming software
- IP66, Type 2 and 4X.

# MICRO PLC - EXCEPTIONAL PERFORMANCE!



- **SYSTEM CONTROL AND SUPERVISION**
  - Contact status viewing in simple pages on display
  - Possibility to add the micro PLC to data networks. By using **Synergy** supervision and energy management software, a multiclient structure can also be managed through Web interface.
- **QUICK CONTROL BOARD INSTALLATION**
  - Fewer number of components
  - Less wiring with minor number of connections.
- **REPETITIVENESS**
  - Less errors during panel assembly
  - Considerable time saving.
- **FLEXIBILITY**
  - Quick correction of abnormal conditions at final testing
  - Fast changes on control boards.

● **FUNCTION BLOCKS AND MEMORY**

Timer (T) (delay on/off, recycle, pulsing, ...)	31
Real Time Clock (RTC) (daily, weekly, monthly and yearly mode)	31
Counter (C)	31
Analog comparator (G)	31
User's pages (H) - 16 characters - 4 lines	31
Auxiliary relays - Markers (M + N memory types)	63 + 63
Arithmetic operation: addition/subtraction and multiplication/division	31 + 31
Data register (DR)	240
Possibility to save in the internal memory:	
- Auxiliary relays	
- Counter values	
- Data registers.	

● **PROGRAM SIZE**

Language	
LADDER (contact scheme)	300 lines
FBD (function blocks)	260 blocks

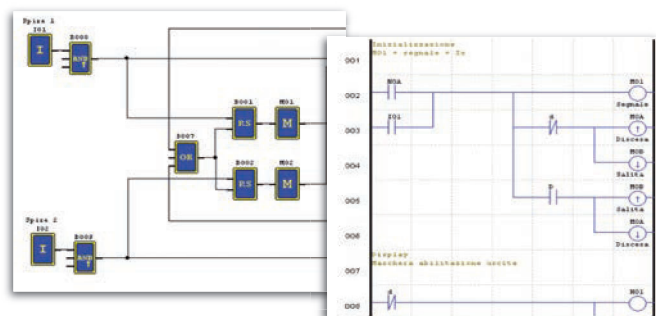

**FUNCTIONS**

● **PWM OUTPUT**

Pulse train generation with programmable pulse time and frequency

$$V_{out} = 24VDC \times \frac{T_{on}}{T}$$

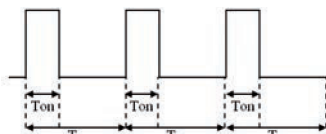

● **MULTIPLEXER**

Selection of 1 of 4 values according to the combination of two digital signals

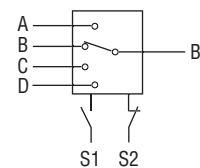

● **HIGH SPEED INPUT**

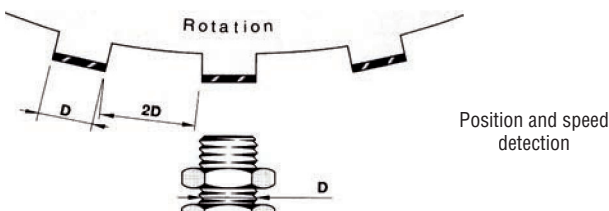

● **SHIFT FUNCTION** - activation of pulsed outputs in sequence

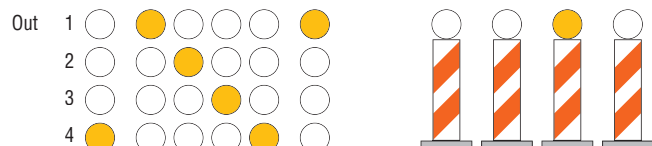

● **PID**

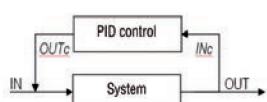

IN: heating switch on and required temperature setting  
 OUT: current room temperature  
 INC: measured room temperature in an exact spot  
 OUTc: temperature adjusting and controlling.

● **BOOLEAN LOGIC BLOCKS**

Output activation based on a series of digital signals

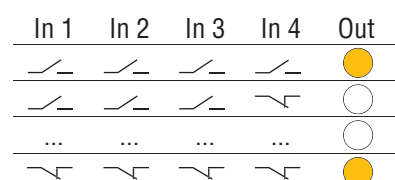

# HMI OPERATOR PANEL LRXP01

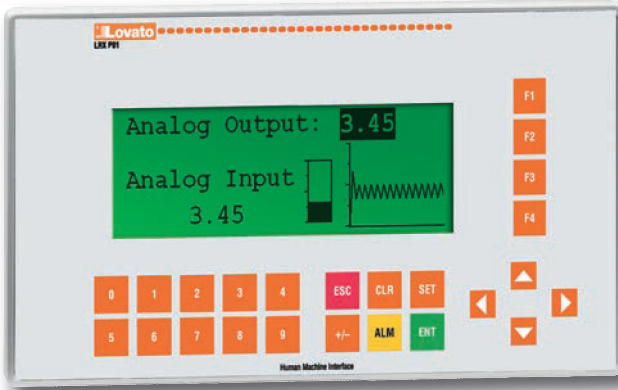

**HMI INTERFACE**

LRXP01 is a HMI operator panel, used with many types of PLCs or other intelligent controllers equipped with communication port with Modbus-RTU protocol.

By using the HMI, the values of both PLC inner registers and relay status can be monitored or modified with the keys of the frontal keyboard. This enables the functioning of machinery and equipment to be simple and direct.

The LRXSWP01 editor software permits to make dedicated screens by taking advantage of the graphic display to view bitmaps, bar graphs and trend lines.

**BACKLIGHT 192x64 PIXEL GRAPHIC LCD**

<p>Read numerical values</p>	<p>Static text</p>	<p>Dynamic text</p>	<p>Read status (bits)</p>	<p>Commands</p>	<p>Write numerical values</p>
<p>Images</p>				<p>Display bar graphs and trend lines</p>	

**COMMUNICATION MODES**

LRXP01 supports Modbus-RTU protocol and can be connected to devices via the integrated RS232 and RS485 communication ports.

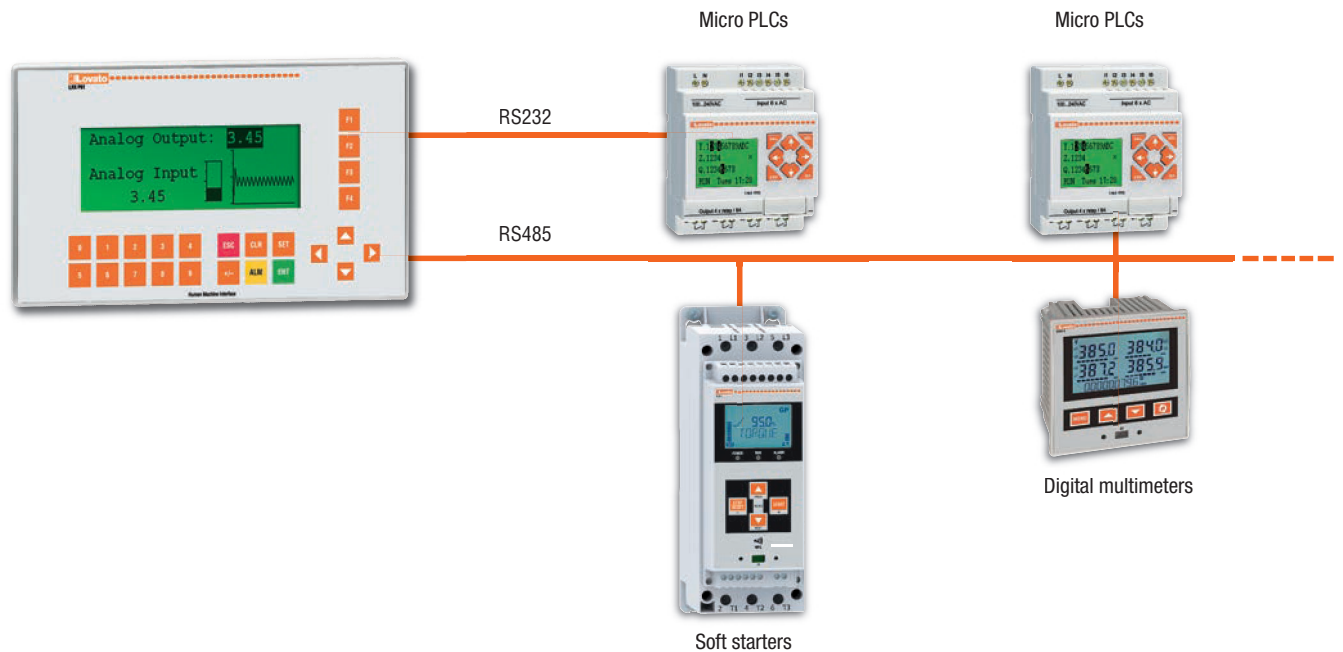

### Base modules



LRD10...  
LRD12...



LRD20RD024P1

Order code	Auxiliary supply voltage	Inputs/Outputs	Qty per pkg	Wt
			n°	[kg]
Base modules.				
LRD12RD024	24VDC	8/4 relay	1	0.241
LRD12TD024	24VDC	8/4 transistor	1	0.220
LRD20RD024	24VDC	12/8 relay	1	0.360
LRD12RA024	24VAC	8/4 relay	1	0.250
LRD20RA024	24VAC	12/8 relay	1	0.368
LRD10RA240	100...240VAC	6/4 relay	1	0.242
LRD20RA240	100...240VAC	12/8 relay	1	0.367
LRD20RD012	12VDC	12/8 relay	1	0.360
Base modules with RS485 onboard.				
LRD20RD024P1	24VDC	12/8 relay	1	0.360

### General characteristics

#### FUNCTIONS

- Addition-Subtraction on variables
- Multiplication-Division on variables
- Comparator on variables
- HMI display for parameter viewing and programming
- PWM output
- High speed input (1kHz)
- PID function
- Multiplexer
- Analog ramp
- Register transfer (numerical variables and status)
- Shift function
- Boolean logic blocks
- LRD20RD024P1 with RS485 port onboard.

#### Operational characteristics

- 8A lth current relay outputs for AC and DC versions
- 0.3A 24VDC transistor outputs for DC version
- 0...10V analog inputs for DC version
- Version: modular for mounting on 35mm DIN rail (IEC/EN/BS 60715) or M4x15mm/0.59" screw fixing
- Type of terminal: Screw
- IEC degree of protection: IP20.

#### Certifications and compliance

Certifications obtained: UL Listed, for USA and Canada (cULus - File E300049), as Programmable Controllers; EAC. Compliant with standards: IEC/EN/BS 61131-2, UL508, CSA C22.2 n°142.

### Expansion and communication modules



LRE...

Order code	Auxiliary supply voltage	Inputs/Outputs	Qty per pkg	Wt
			n°	[kg]
Expansion and communication modules❶.				
LRE02AD024	24VDC	2 analog outputs 0...10V/0...20mA	1	0.160
LRE04AD024	24VDC	4 analog inputs 0...10V/0...20mA	1	0.160
LRE04PD024	24VDC	4 PT100 temp. sensor inputs	1	0.160
LRE08RD024	24VDC	4/4 relay	1	0.171
LRE08TD024	24VDC	4/4 transistor	1	0.151
LRE08RA024	24VAC	4/4 relay	1	0.180
LRE08RA240	100...240VAC	4/4 relay	1	0.180
LREP00	RS485 Modbus-RTU protocol communication unit		1	0.134

❶ The expansion modules are supplied with connector for base module.

#### INPUTS/OUTPUTS REFERENCE TABLE

BASE MODULES				BASE + DIGITAL EXPANSIONS
Type	Power supply	Inputs	Outputs	Max I/O
LRD12RD024	24VDC	6 digital + 2 digital/analog	4 relay	12 + 24
LRD12TD024	24VDC	6 digital + 2 digital/analog	4 transistor	12 + 24
LRD20RD012	12VDC	8 digital + 4 digital/analog	8 relay	20 + 24❷
LRD20RD024	24VDC	8 digital + 4 digital/analog	8 relay	20 + 24
LRD20RD024P1	24VDC	8 digital + 4 digital/analog	8 relay	20 + 24
LRD10RA240	100...240VAC	6 digital	4 relay	10 + 24
LRD20RA240	100...240VAC	12 digital	8 relay	20 + 24
LRD12RA024	24VAC	8 digital	4 relay	12 + 24
LRD20RA024	24VAC	12 digital	8 relay	20 + 24
EXPANSION AND COMMUNICATION MODULES				
LRE02AD024	24VDC	—	2 analog	—
LRE04AD024	24VDC	4 analog	—	—
LRE04PD024	24VDC	4 PT100	—	—
LRE08RD024	24VDC	4 digital	4 relay	—
LRE08TD024	24VDC	4 digital	4 transistor	—
LRE08RA240	100...240VAC	4 digital	4 relay	—
LRE08RA024	24VAC	4 digital	4 relay	—
LREP00	24VDC	RS485 Modbus-RTU protocol slave communication unit		

❷ Expansion modules supplied at 24VDC.

### Accessories



LRX1V3D024



LRXM00



LRXC03

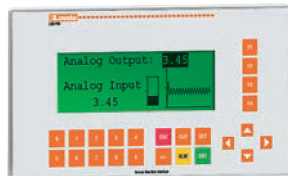

LRXP01



LRXC02

### Kit



LRDKIT...



LRDDEM...

Order code	Description	Qty per pkg	Wt
		n°	[kg]
LRXM00	Program backup memory	1	0.011
LRXC00	PC (RS232)-LRD programming cable or LRXP01 (RS232)-LRD direct connection	1	0.083
LRXC03	PC (USB)-LRD programming cable	1	0.080
LRXSW	Programming and supervision software (CD-ROM)	1	0.057
LRX1V3D024	Power supply unit, 100...240VAC/24VDC, 1.3A modular version (4U)	1	0.220
LRXP01	HMI operator panel, 24VDC, RS232, RS485 (Modbus-RTU Master)	1	0.200
LRXC02	PC (RS232)-LRXP01 programming cable	1	0.180
LRXSWP01	Programming software for LRXP01 operator panel (CD-ROM)	1	0.057

Order code	Description	Qty per pkg	Wt
		n°	[kg]
Kits.			
LRDKIT12RD024	LRD starter kit with LRD12RD024 base module, LRXSW software and LRXC03 cable	1	0.424
LRDKIT12RA024	LRD starter kit with LRD12RA024 base module, LRXSW software and LRXC03 cable	1	0.424
LRDKIT10RA240	LRD starter kit with LRD10RA240 base module, LRXSW software and LRXC03 cable	1	0.424
Training kits.			
LRDDEM12RD024	Training kit with LRD12RD024 mounted on inputs/outputs simulation board	1	0.920
LRDDEM20RD024	Training kit with LRD20RD024 mounted on inputs/outputs simulation board	1	1.060

### Backup memory and power supply unit general characteristics

- The LRXM00 backup memory allows the saving of the user's program and to simply and quickly transfer it to other base modules.
- The LRX1V3D024 power supply produces a DC voltage to supply the LRD base and expansion modules when 24VDC is not available in the panel. The power supply can also be used to power eventual 24VDC auxiliary circuits.

### HMI panel LRXP01 general characteristics

- 24VDC power supply
  - RS232 communication port:
    - Direct connection to LRD base modules using cable LRXC00
    - Connection to other devices using a standard D-SUB 9 serial cable
  - RS485 communication port
  - LRXSWP01 editor software for graphic pages configuration
  - IEC degree of protection: IP65.
- #### FUNCTIONS
- Send commands
  - Read status
  - Static and dynamic texts
  - Write variables
  - Read variables:
    - Numerical values
    - Bar graphs
    - Trends.

### Programming using software LRXSW

At any time and with extreme simplicity, LRD can be set up and reprogrammed to satisfy new requirements and improve the operation of a system.

Programming is simple and intuitive and can be done directly on the base module keypad or by personal computer, connected by LRXC00 (RS232) or LRXC03 (USB) interface and using the relative LRXSW software freely downloadable from [www.LovatoElectric.com](http://www.LovatoElectric.com).

With a personal computer, two programming languages can be used: FBD (Function Block Diagrams) and LADDER (contact scheme).

Both of the following can be accomplished:

- Simulate the program directly "off-line" with a personal computer to test if it runs correctly.
- Use the supervision mode to check the project "on-line".

8 function keys on the front, dedicated to on-board adjustment, control and supervision of digital input and output status, analog input values, time and date entry and the operation status of the micro PLC itself.

### Certifications and compliance

Certifications obtained: UL Listed, for USA and Canada (cULus - File E300049), as Programmable Controllers for power supply and HMI units and base module of kits, EAC. Compliant with standards: IEC/EN/BS 61131-2, UL508, CSA C22.2 n°142.

#### Maximum combinations

Base unit  
12 inputs  
+  
8 outputs

4 inputs  
+  
4 outputs

4 inputs  
+  
4 outputs

4 inputs  
+  
4 outputs

4 PT100  
temperature  
sensor inputs

2 outputs,  
0...10V or  
0...20mA

2 outputs,  
0...10V or  
0...20mA

4 inputs,  
0...10V or  
0...20mA

RS485  
Modbus-RTU  
(slave)

- 24 digital inputs (4 configurable as analog 0...10V input)
- 20 digital outputs (relay, transistor or mixed)
- 4 analog inputs for PT100 temperature sensors
- 4 analog outputs configurable as 0...10V or 0/4...20mA
- 4 analog inputs configurable as 0...10V or 0/4...20mA
- 1 RS485 communication module.

N.B. The sequence and the maximum number of the products given above must be respected for correct operation.

# HMI LRH SERIES



## ● HMI WITH COLOR TOUCHSCREEN DISPLAY

The HMI LRH series have a graphic TFT display with 64k colors, touchscreen, easy to program and extremely flexible. They can be interfaced with different type of devices, from PLC to any kind of intelligent controller provided with communication port, like multimeters, drives, process controllers. The LRHSW programming software allows the configuration of the HMI in a simple and intuitive way, thanks to the graphical interface with which you can create customized screens to show images, trends, bar graphs, analog indicators, dynamic objects and other functionalities. The HMI LRH series are the ideal solution for the supervision and control of small and large automation scenarios that are more and more required in the world of Industry 4.0.

## ● WIDESCREEN DISPLAY WITH HIGH VISIBILITY

- TFT display with resistive touchscreen
- High brightness thanks to the LED backlighting
- 64k colors
- Available in formats 4.3", 7" and 10.1".

## ● SIMPLICITY AND EFFICIENCY

- Simple and elegant design with low energy consumption
- High robustness, thanks to the use of highly reliable industrial components
- Plastic enclosure, degree of protection IP66, Type 2 and 4X.

## ● CONNECTIVITY FOR EASY INTEGRATION

- 3 built-in communication ports: Ethernet, USB and serial (type RS232-RS485-RS422, configurable via software LRHSW)
- Support of communication protocols Modbus-RTU Master/Slave, Modbus TPC Client/Server, OPC UA Client/Server, Simatic S7 Ethernet and MQTT.

## ● POWERFUL AND INTUITIVE PROGRAMMATION

- High performance CPU
- Extensive gallery of widgets, objects and pre-configured scenarios for typical applications
- Data acquisition and display on numeric indicators, trends or graphical gauges
- Support of vector graphics, images, analog indicators, bar graphs
- Advanced functionalities: dynamic objects, alarms and events management, support of multilingual applications, recipes, tags editor, user and password management, script language
- Advanced properties of the objects: e-mail, events scheduler, etc
- Support of HTML5 and JavaScript
- Possibility to simulate the program by working off-line.



- Power supply 12-24VDC
- USB port
- Ethernet port 10/100 MBIT
- Serial port RS485, RS232, RS422



## ● PRE-CONFIGURED SCENARIOS

Preconfigured and ready to use scenarios for typical applications managed with LOVATO Electric products (remote control of a micro PLC, supervision of a pumping station with variable speed drive, monitoring of a photovoltaic system with energy meter, soft starter monitoring, control and supervision of a power factor correction plant, monitoring of an automatic transfer switch ATS panel, command and monitoring of a mains-generator application, etc.) freely downloadable from the website [www.LovatoElectric.com](http://www.LovatoElectric.com), download section, software & upgrades.

### HMI



LRHA04



LRHA07



LRHA10



EXCCAB02

Order code	Description	Qty per pkg	Wt
		n°	[kg]
HMI.			
<b>LRHA04</b>	4.3" TFT LCD display	1	0.400
<b>LRHA07</b>	7" TFT LCD display	1	0.600
<b>LRHA10</b>	10.1" TFT LCD display	1	1.000
Programming software for HMI.			
<b>LRHSW01</b>	User licence for LRHSW software (available for download from <a href="http://www.LovatoElectric.com">www.LovatoElectric.com</a> website), valid for 1 station	1	—
<b>LRHSW01CD</b>	CD-ROM with LRHSW programming software, including one LRHSW01 licence	1	0.057
RS485 connection cable.			
<b>EXCCAB02</b>	RS485 connection cable for LRH, length 3m	1	0.150
HMI kits and micro PLC.			
<b>LRDKITHMIA04</b>	Kit with LRD20RD024P1 micro PLC, LRHA04 HMI and EXCCAB02 cable	1	1.000
<b>LRDKITHMIA07</b>	Kit with LRD20RD024P1 micro PLC, LRHA07 HMI and EXCCAB02 cable	1	1.200

Model	LRHA04	LRHA07	LRHA10
<b>SYSTEM RESOURCES</b>			
Display	4.3" TFT 16:9	7" TFT 16:9	10.1" TFT 16:9
Colors	64K		
Resolution	480x272 pixel	800x480 pixel	1024x600 pixel
Brightness	200Cd/m <sup>2</sup>		
Dimming	Yes		
Touchscreen	Resistive		
CPU	ARM Cortex A8 300MHz	ARM Cortex A8 1GHz	ARM Cortex A8 1GHz
Operative system	Linux 3.12		
Flash	2GB	4GB	4GB
RAM	256MB	512MB	512MB
Application memory	60MB		
Real Time Clock, RTC backup, Buzzer	Yes		
<b>INTERFACES</b>			
Ethernet	1 (10/100 Mbit)		
USB	1 (Host v2.0, max 500mA)		
Serial	1 (RS232, RS485, RS422, software configurable)		
<b>FUNCTIONALITIES</b>			
Vector graphics	●		
Dynamic objects	●		
Font TrueType	●		
Alarms	●		
Event list	●		
Recipes	●		
User management	●		
Trends	●		
Multi-language management	●		

### General characteristics

- Widescreen display with resistive touchscreen
- Available in formats 4.3", 7" and 10.1"
- LED backlight
- Ethernet, USB and serial port (type RS232-RS485-RS422, configurable via software LRHSW)
- Lightweight and low-power design
- Highly reliable industrial components
- Powerful and intuitive programming with software LRHSW (downloadable from the website [www.LovatoElectric.com](http://www.LovatoElectric.com) or purchasable on Cd-rom), with 30-days trial license included
- Support of protocols Modbus-RTU Master/Slave, Modbus-TCP Client/Server, OPC UA Client/Server, Simatic S7 Ethernet and MQTT
- Support of vector graphics
- Rich library of preconfigured and ready to use graphical objects (widgets): static or dynamic images, buttons, sliders, lights, bar graphs, gauges, meters, media widgets, etc.
- Possibility to create custom widgets
- Tags editor to create, import or export tags
- Alarm handling with management of events and actions (e.g. alerts with pop-up messages, send email, write tags, etc.)
- Data-logging with presentation of the collected data in graphical trends and tables, with possibility to save the data in a .CSV file
- Recipe data handling
- Scheduler engine to execute specific actions at set intervals, or on a time basis
- Automatic generation of customizable reports
- Multilingual projects management with texts in True Type font
- Data transfer function to exchange data between the devices connected to the HMI
- Powerful script language with JavaScript editor
- Web access: support of HTML5 technology to allow users to access HMI projects from a remote web browser running on a computer or on a mobile device (smartphone or tablet)
- Advanced user management with possibility to configure different levels of authorizations and permissions on the access to pages or to the actions on the widgets of the projects, with dedicated credentials
- Monitoring and remote control of the project running on the HMI from a PC with the software LRHSW Client, installed together with the programming software LRHSW
- On-line and off-line simulation of the applications.

### Operational characteristics

- Rated auxiliary power supply: 12-24VDC
- Operating range: 10...32VDC
- Operating temperature: 0...+50°C
- Storage temperature: -20...+70°C
- Humidity: 5-85% RH, non condensing
- Protection degree: IP66, Type 2 and 4X (front); IP20 (rear).

### Preconfigured scenarios

Preconfigured and ready to use scenarios for typical applications managed with LOVATO Electric products (remote control of a micro PLC, supervision of a pumping station with variable speed drive, monitoring of a photovoltaic system with energy meter, soft starter monitoring, control and supervision of a power factor correction plant, monitoring of an automatic transfer switch ATS panel, command and monitoring of a mains-generator application, etc.) freely downloadable from the website [www.LovatoElectric.com](http://www.LovatoElectric.com), download section software & upgrades.

### Certifications and compliance

Certifications obtained: UL Listed, for USA and Canada (cULus – File E199715), EAC, RCM.  
Compliant with standards: emissions EN/BS 61000-6-4, immunity EN/BS 61000-6-2 for installation in industrial environments; emissions EN/BS 61000-6-3, immunity EN/BS 61000-6-1 for installation in residential environments; UL508.



**BASE MODULES**  
LRD10... - LRD12...

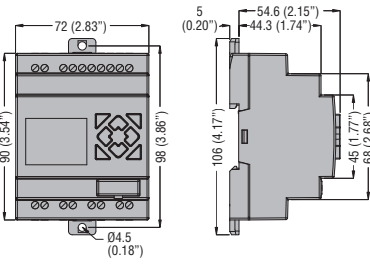

**LRD20...**

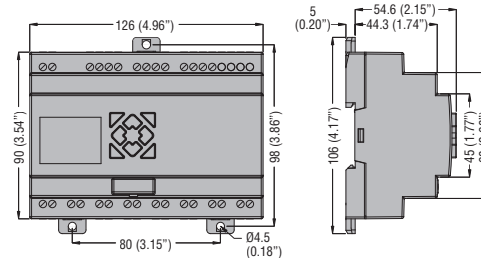

**EXPANSION AND COMMUNICATION MODULES**  
LRE...

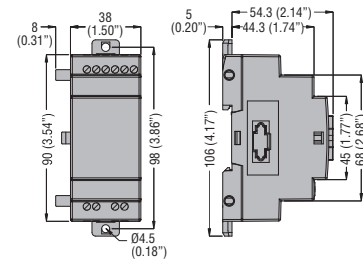

**ACCESSORIES**

**LRX1V3D024** power supply unit

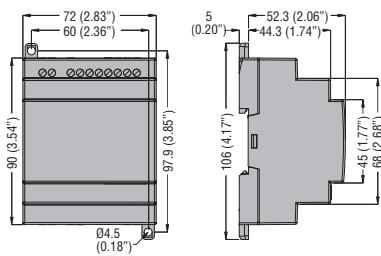

**LRXP01** HMI operator panel

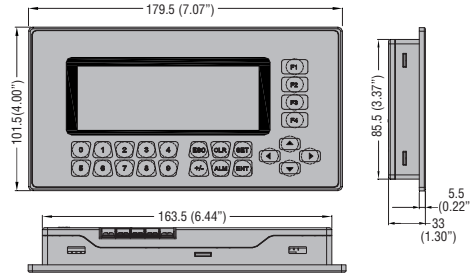

**Cutout**

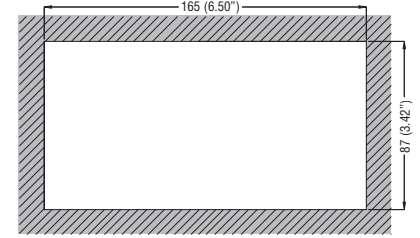

**HMI**

**LRHA04**

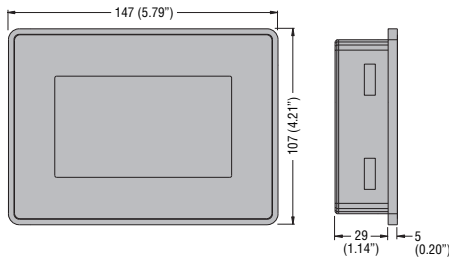

**Cutout**

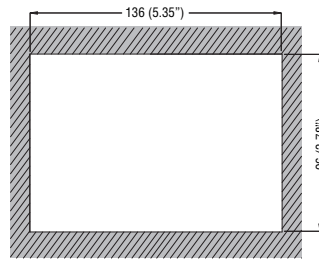

**LRHA07**

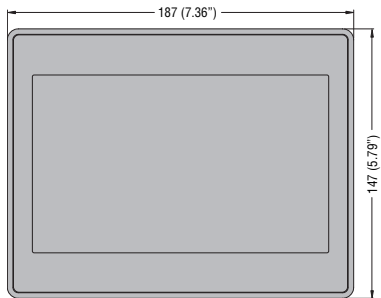

**Cutout**

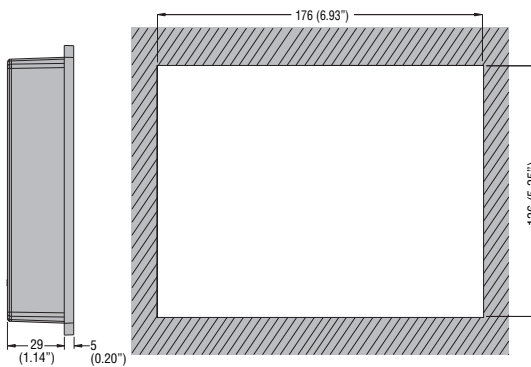

**LRHA10**

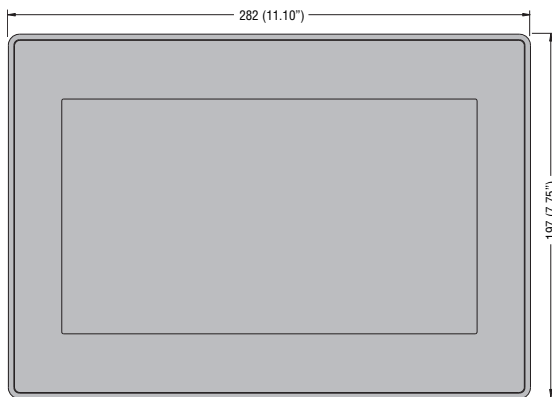

**Cutout**

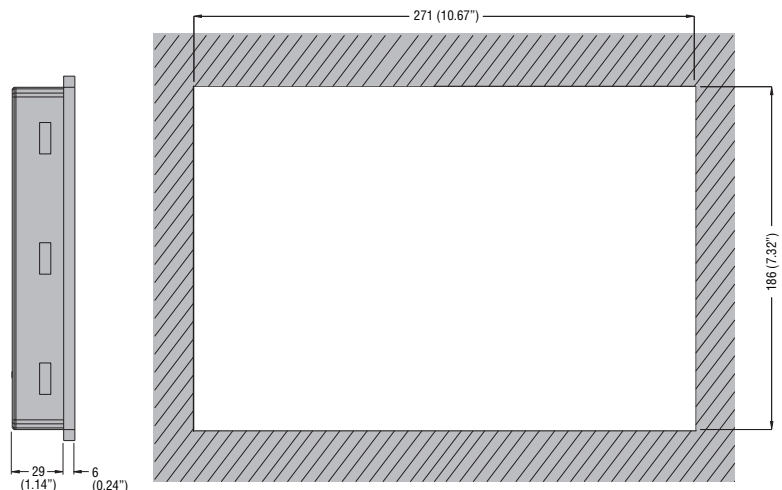

### BASE MODULES

#### LRD12RD024

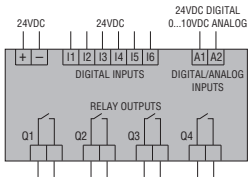

#### LRD12TD024

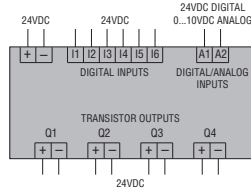

#### LRD12RA024

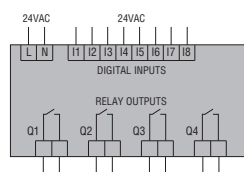

#### LRD10RA240

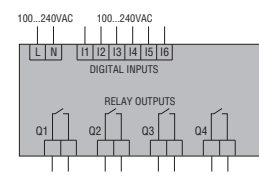

#### LRD20RD012 - LRD20RD024

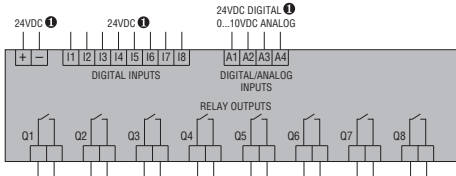

① 12VDC for LRD20RD012.

#### LRD20RD024P1

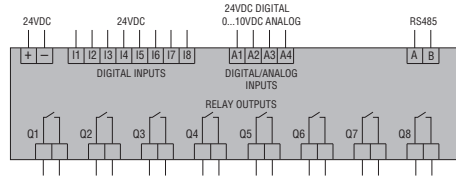

#### LRD20RA240

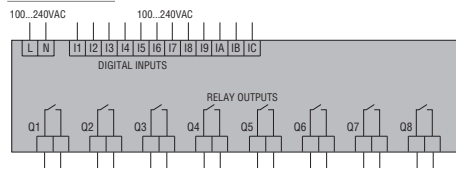

#### LRD20RA024

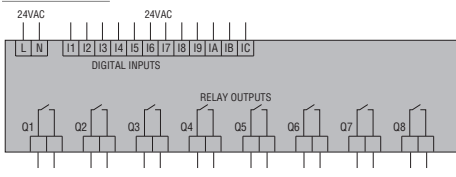

### EXPANSION AND COMMUNICATION MODULES

#### LRE02AD024

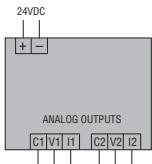

#### LRE04AD024

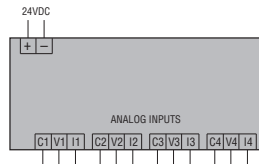

#### LRE04PD024

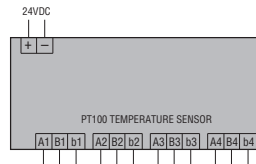

#### LRE08RD024

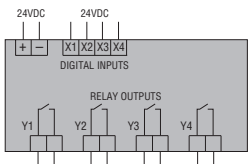

#### LRE08TD024

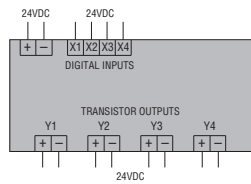

#### LRE08RA024

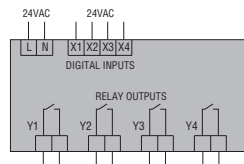

#### LRE08RA240

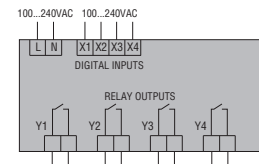

### ACCESSORIES

#### Power supply unit

##### LRX1V3D024

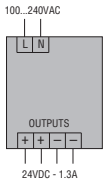

#### RS485 communication unit

##### LREP00



#### Operation panel

##### L\_RXP01

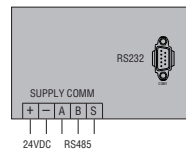

### HMI

#### LRHA...

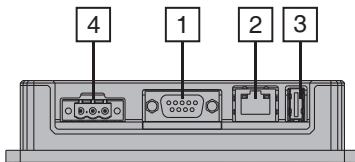

- 1 Serial port (type RS232, RS485, RS422 software configurable)
- 2 Ethernet port
- 3 USB port
- 4 Power supply 12-24VDC

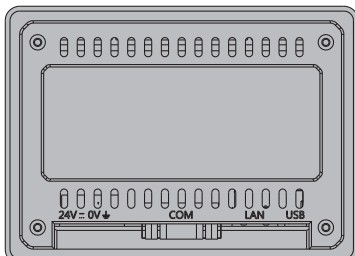

BASE MODULES		LRD...D012	LRD...D024	LRD...A024	LRD...A240
<b>POWER SUPPLY</b>					
IEC rated voltage Ue (frequency range)		12VDC	24VDC	24VAC (50...60Hz)	100...240VAC (50...60Hz)
Operating limits		10.4...14.4VDC	20.4...28.8VDC	20.4...28.8VAC (47...63Hz)	85...265VAC (47...63Hz)
Average current consumption		265mA	125mA (LRD12...) 185mA (LRD20...)	290mA	100mA
<b>DIGITAL INPUTS</b>					
Rated voltage		12VDC	24VDC	24VAC (50...60Hz)	100...240VAC (50...60Hz)
Input voltage	State 0	<2.5VDC	<5VDC	<6VAC	<40VAC
	State 1	>7.5VDC	>15VDC	>14VAC	>79VAC
Delay time	0 to 1	4ms (0.5ms for high speed)	4ms (0.5ms for high speed)	90ms	50/45ms (Ue=120VAC) - 22/18ms (Ue=240VAC)
	1 to 0	4ms (0.3ms for high speed)	4ms (0.3ms for high speed)	90ms	50/45ms (Ue=120VAC) - 90/85ms (Ue=240VAC)
<b>ANALOG INPUTS (FOR DC SUPPLY VERSIONS ONLY)</b>					
Input signal range		0...10V		—	—
Display resolution		0.01V		—	—
Current consumption at 10VDC		<0.17mA		—	—
Input impedance		>40kΩ		—	—
Admissible overload		14VDC	28VDC	—	—
Sampling time		5...20ms (LADDER); 2...10ms (FBD)		—	—
Maximum cable length		≤30m/98ft of screened type		—	—
<b>DIGITAL OUTPUTS</b>					
Type of output / IEC rated current Ith		Relay / 8A (LDR...R... / LRE08R... only) Transistor / 0.3A 24VDC (LRD...T... / LRE08T... only)			
Applied voltage		Max 265VAC / 30VDC (LDR...R... / LRE08R... only) 10...28.8VDC (LRD...T... / LRE08T... only)			
<b>AMBIENT CONDITIONS</b>					
Operating temperature		-20...+55°C			
Storage temperature		-40...+70°C			
Relative humidity		20...90% without condensation			
<b>HOUSING</b>					
Version		Modular for mounting on 35mm DIN rail (IEC/EN/BS 60715) or M4x20mm screw fixing			
Connections	Type of terminal	Screw			
	Conductor section	0.14...2.5mm <sup>2</sup> / 26...14AWG			
	Tightening torque	0.6Nm / 5.3lb.in			
	Maximum cable length	≤100m/328ft			
IEC degree of protection		IP20			

EXPANSION MODULES		LRE02AD024	LRE04AD024	LRE04PD024		
<b>POWER SUPPLY</b>						
IEC rated voltage Ue		24VDC	24VDC	24VDC		
Operating limits		20.4...28.8VDC	20.4...28.8VDC	20.4...28.8VDC		
<b>ANALOGIC INPUTS/OUTPUTS</b>						
Type of channels		2 outputs configurable for voltage or current		4 inputs for PT100 temperature sensors		
Operating limits		0...10V	0...20mA	0...10V	0...20mA	-100...+600°C
Display resolution		0.00...10.00V	0.00...20.00mA	0.00...10.00V	0.00...20.00mA	-100.0...+600.0°C
Resolution		10mV	40μA	10mV	40μA	0.1°C
Accuracy		±2.5%		±2.5%		±1%
Power consumption		70mA		70mA		70mA

COMMUNICATION MODULE		LREP00
IEC rated voltage Ue		24VDC
RS485 connection		Isolated
Baud-rate		4800...57600bps
Terminator resistor		Integrated 120Ω
Cable length		0.14...1.5mm <sup>2</sup> (26...16AWG)
Tightening torque		0.6Nm (5.4lb.in)

HMI OPERATOR PANEL	<b>LRXP01</b>
SUPPLY	
IEC rated voltage Ue	24VDC
Operating limits	20.4...26.4 VDC (-15%...+10%)
Power consumption	1.9 W
AMBIENT CONDITIONS	
Operating temperature	0...+55°C
Storage temperature	-40...+70°C
Altitude	≤2000m
Relative humidity	10...95% (non-condensing)
Maximum pollution degree	2 (IEC/EN/BS 61131-3)
Vibration resistance	15g
Shock resistance	0.5g
Conductor section	0.4...3.3 mm <sup>2</sup> (22-12 AWG)
Tightening torque	1.8 Nm / 10.4lb.in
IEC degree of protection	IP65

HMI	<b>LRHA04</b>	<b>LRHA07</b>	<b>LRHA10</b>
POWER SUPPLY			
Rated voltage Ue	12-24VDC		
Operating range	10...32VDC		
Max current consumption at 24VDC	0.25A	0.3A	0.38A
ENVIRONMENT CONDITIONS			
Operating temperature	0...+50°C		
Storage temperature	-20...+70°C		
Relative humidity	5...85% (non condensing)		
Protection degree	IP66, Type 2, 4X (front); IP20 (rear)		